



UPPER ISLAND SOCCER ASSOCIATION

UIISA – EXECUTIVE MEETING

Thursday March 16, 2017

Via webex– 8:40 pm

MINUTES

Present: Kevin Cowie, Brad Nixon, Marc Paris, Sean Arbour, Sam White, Carl Neibel

Absent: Warren Cudney

Guests: Christine Carson (UIISA Administrator)

1) **Additions/Adoption of Agenda**

MOTION: To accept the agenda as amended.

Brad/Marc

CARRIED

2) **Minutes of Previous Meeting February 6, 2017**

MOTION: To accept the minutes as submitted.

Brad/Marc

CARRIED

3) **Correspondence:**

Feb 10 – from BCSA –Quarterly competitions memo –fwd to exec Feb 10, sent by BCSA directly to clubs

Feb 15 – from BCSA – Reminder to submit AGM dates and board outreach program

Feb 27 – from BCSA –Updated BC Soccer Rules and Policies– forwarded to UIISA exec Mar 15, sent by BCSA directly to clubs

Feb 27 – from LISA –LISA newsletter– forwarded to exec

Feb 28 – from BCSA–Youth forum/District President’s meeting reminder

Mar 8 – from BCSA – BC soccer celebrates International Women’s Day - forwarded to UIISA exec Mar 15, sent by BCSA directly to clubs

Mar 14 – from BCSA –BC Soccer Certificate of Insurance and Reminders– forwarded to UIISA exec Mar 15, sent by BCSA directly to clubs

Old Business:

- a) **Meeting dates and locations** – see list below. Christine to survey best April date for in-person meeting in Comox Valley.
- b) **B- Cup playdowns in UIISA** – see Appendix 1 and 2 for updated girls and boys brackets
- c) **A- cup playdowns in VIPL** - see Appendix 3 for completed girls and boys brackets
- d) **Pacific Development Jamboree update** – participant feedback survey results. Sean shared results of online survey responses and Sam shared email responses from girls event. Comments very consistent between two events and quite positive. Suggestion from both events to do the jamboree during the fall – could fit in the weekend between the end of seeding round and the start of tiered pools for league play. Use of pinnies worked well – do not need t-shirts. Great to mix coaches as well.

4) **New Business:**

- a) **Pacific Development Cup finals** – see Appendix 4 and 5 for completed girls and boys brackets.
- b) **HCFC Tournament sanction** – Discuss application, do we need a stipulation to prevent U11 teams playing at HCFC instead of MWC, how to handle mixed-age teams, limitations should apply to teams from other areas, what is the entry fee? \$200 per team.
MOTION: to approve the HCFC tournament sanction application with the stipulation that underage teams (U11) may not challenge and participate
Brad/Sam **CARRIED**
- c) **RUSH Academy tournament sanction** – Discuss application – no known conflicts for the date. Brad attended last year and event ran well, charitable donation was made at the field.
MOTION: to approve the RUSH academy tournament sanction application, with the stipulation that 1) proof of BC Soccer associate membership renewal is provided to UISA before the tournament and 2) a financial statement is provided to UISA within 30 days of the event which includes event income, event expenses and amounts donated to charity.
Kevin/Sean **CARRIED**
- d) **Lower Island Associate Membership Application** – already approved by LISA and VISL – UISA would be the third signer
MOTION: to approve the short-term associate membership application from the PLAY society
Kevin/Brad **CARRIED**
- e) **MWC update:** 53 teams registered, with Comox (expecting 24 teams) still to come. Event will be full with 80 teams, looks like they will reach that number.
- f) **2017 Island Invitational** – roster change requests from U13 teams. Several teams (one boys, one girls) have had player availability change and will have a short bench. Should UISA revisit the issue of permits/pickups in district playdowns? Take the issue to the Tier 3 SC and consider changes for next year. Policy should be consistent across Island Invitational and Pacific Development Cup playdowns. Changes need to be in place by start of season so teams understand the rules before they declare.
- g) **2018 Island Invitational** – UISA host – Powell River has confirmed that they will host the 2018 Island Invitational finals.
- h) **2017-18 – UISA league** – change of game day? Consider the distribution of games between Sat and Sunday – could changing some UISA divisions to Saturday give easier field access? Probably a big conflict with house and limits the Tier 3 kids who can ref house games.
- i) **Report from Riptide and Storm steering committees** – **Sean** – congrats to all Riptide teams, all of whom made the VIPL finals, and three teams will advance to the Coastal Cup and Provincial finals. 6 Riptide teams enjoyed Mayors Cup last weekend. Asking BC Soccer for exception to new fixed accommodation rule for Provincials for Riptide who stay together in one facility. 2004 training sessions weathered out this year, so now going forward in March break with these sessions.
Carl – congrats to the 2 Storm teams going to Coastal Cup and Provincials. Good showing for Storm in league standings and playdowns. Good interest in Storm players at BC SPL. Will track players that head off to University. Coaching

applications now open, and Larry looking at running C-license training for Storm coaches. Looking for a sponsor, and for some program development in the next year. Still some issue with Whitecaps taking players without proper notice.

- j) **UISA President's Meeting – Kevin** Club presidents to consider increasing the initial fall registration payment to 80%, clubs encouraged to pressure school boards to coordinate school breaks across the Island, which would give us two more weeks of play every spring, clubs to bring suggestions for appropriate follow-up for missing CRCs to next UISA meeting, updated steering committee terms of reference and supporting documents presented and discussed, UISA AGM procedures discussed and UISA will move forward with board candidate declarations ahead of time in writing, and suggested change in voting structure to one vote per club.
 - k) **BC Soccer Presidents Meeting Mar 16** – BC Soccer still working on referee CRCs, looking to survey players who have left soccer in the last year, to try and understand loss of older youth better, registration down from last year (2.5%), BC Soccer producing new templates for new constitution and bylaws changes need to comply with the Societies Act legislation, which will be available in about a month, Provincial cup seedings problematic in the Lower Island due to weather this year, BC Soccer grants now available, including grant in honour of Women's day.
 - l) **BC Soccer Award of Merit** – suggested nominee for 2017 has been sent to UISA – we will submit to BC Soccer. Carl will make a nomination for youth referee of the year.
- 5) **Treasurer's Report:** Late registration income report circulated to board.
- 6) **Registrar's Report:** Late registration breakdown circulated to board, but more data form 1-2 late clubs still to be added.
- 7) **Administrator's Report:** Spring break office closure- March 20 – 27.
- a) **League play:**
 - i. **BCSPL Update:** Tyler Griffith from Comox and Fergus Hall from Campbell River currently participating in the U15 national camp.
 - ii. **VIPL Update:** 2016-17 league play complete, U17 A-cup division has been established for 2016-17 in the Lower Mainland, notice did not go out until November so Storm and Riptide were unable to plan teams for the season that took the change into account. Anticipating both boys and girls U17 A-cup for 2017-18, as well as U18s. Not sure if Storm and Riptide can field both U17 and U18 – hasn't worked well for Storm in the past. BC Soccer looking for a transitional league experience for U18-U21.
 - iii. **Gold/UISA League Update:** 2016-17 league play complete.
 - b) **Provincial Cup, Coastal and District Cup play:** See Appendix 1 and 2 for 2017 B- cup playdown update and Appendix 3 for 2017 VIPL playdown results. See Appendix 4 and 5 for U14-U18 girls and boys Pacific Development Cup results.
- 8) **Technical Committee: Carl** – Bays United U18B looking for games in April for a visiting team from Calgary- opportunity for Riptide and Storm. Good competitive playdown games

across most of B-cup and Pac Dev Cup. BC Soccer impressed by UISA initiative to establish TD meetings. HCFC and partners in regional house league going to 8-aside next year.

- 9) **Discipline/Officials:** Referee reimbursement rate for cup play – BC Soccer has different rates for A- and B- cup. UISA to pay \$40/\$45/\$50 as per last year. A-cup playdown protest – not upheld. VIPL rules need to be clarified regarding officials at cup playdowns. VIPL red card in final (coastal Cup play). UISA asked for BC soccer to review suspension, which was reduced.

- 10) **AOB:**

Adjournment

Future Meeting Dates:

UISA Executive Meeting:

Thursday March 16, 2017 –via remote link – 7:00 PM

Monday April 10, 2017 – CVUSC Clubhouse, Courtenay – 7:00 PM

Monday May 8, 2017 - in person or remote link – 7:00 PM

Monday, June 5, 2017 – Quality Inn Bayside, Parksville – 7:00 PM

UISA General Meeting dates:

Saturday, May 27, 2017 at Quality Inn Bayside, Parksville - 12:30 PM

UISA Tier 3 Steering Committee meeting dates:

Saturday, April 15, 2017 at Quality Inn Bayside, Parksville – 11 AM

UISA Annual General Meeting date:

Saturday, May 27, 2017 at Quality Inn Bayside, Parksville - 11:00 AM

Appendix 1: UISA U14-U18 Girls B-cup playdowns to date

U 14 Girls

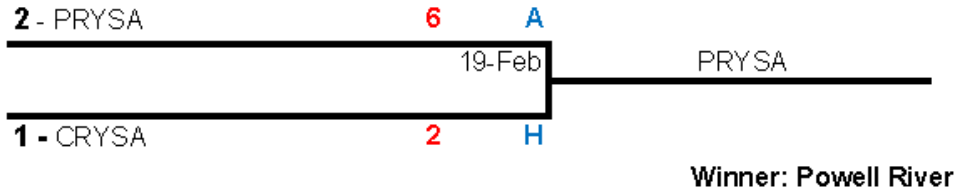

UISA vs LISA game will be played Feb 25 in Lower Island against Peninsula/Prospect Lake PR 1 Pen/Prospect 0 in PKs

U 15 Girls

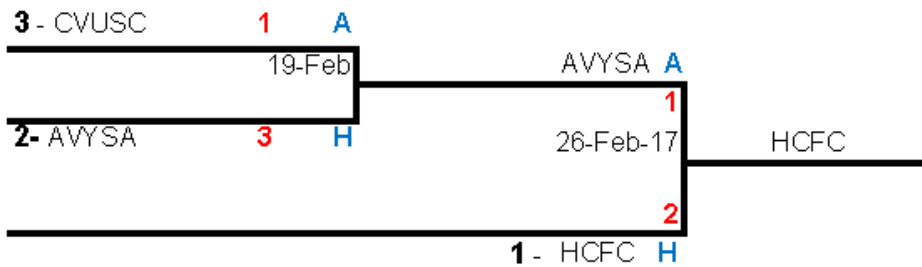

UISA vs LISA game will be played: April 9 in Nanaimo against Peninsula/Prospect Lake

U16G

OYSS UISA vs LISA game will be played Feb 25 in Lower Island against Gorge/Lakehill OYSS 0 G/L 2

Winner: Gorge/Lakehill

U17G

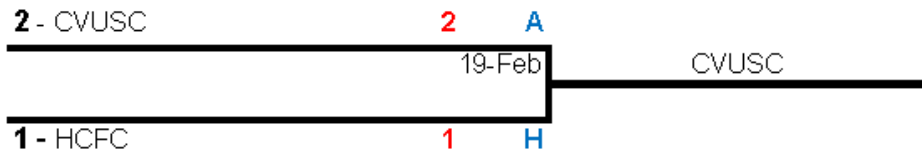

UISA vs LISA game will be played: April 2 in Comox Valley against Cowichan

U18G

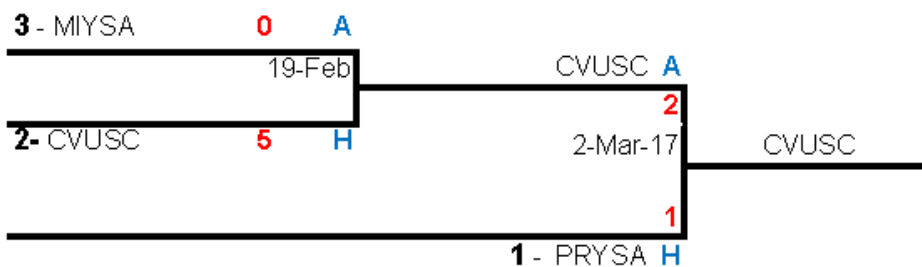

UISA vs LISA game will be played: April 9 in Lower Island against Juan de Fuca

Appendix 2: UISA U14-U18 Boys B-cup playdowns to date

U14 Boys

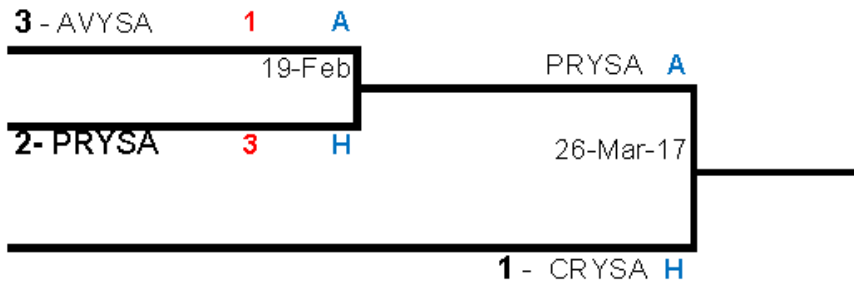

UISA vs LISA game will be played:
April 8 in Lower Island
against Juan de Fuca

U 15 Boys

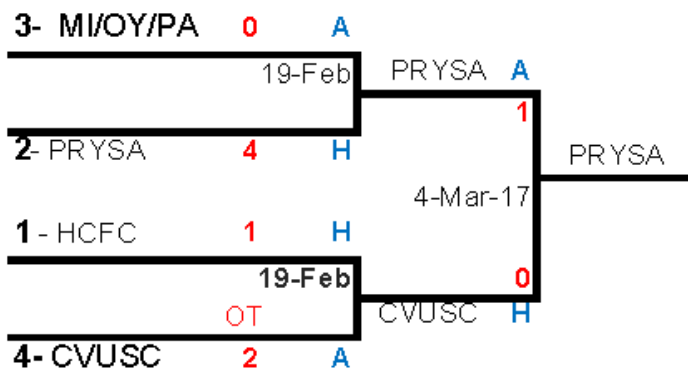

UISA vs LISA game will be played:
April 9 in Powell River
against Juan de Fuca Blue

U16 Boys

CVUSC **UISA vs LISA** game will be played:
against Bays United Sabotage

April 8 in Lower Island

U17 Boys

PRYSA **UISA vs LISA** game will be played:
against Saanich Fusion
PR 1 SF 5

Feb 26 in Powell River

Winner: Saanich Fusion

U18 Boys

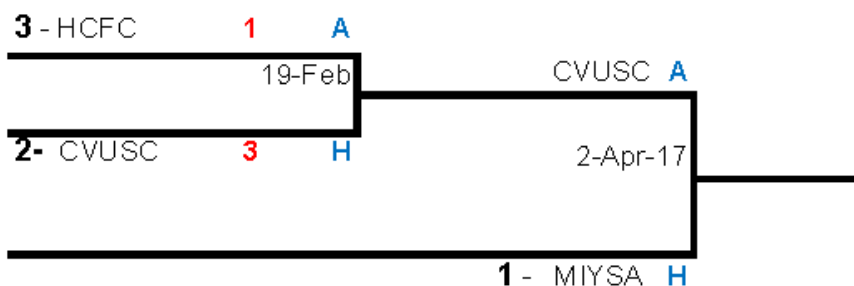

UISA vs LISA game will be played:
April 9 in Lower Island
against Bays United Ultras

Appendix 3: 2017 VIPL A-cup playdown results

Girls U14 VIPL - 2016/17

Girls U14 TEAMS SEEDED FROM LEAGUE PLAY

CONTACTS

1. UI Riptide (Duncan)
2. UI Storm (Noon)
3. Saanich Fusion/Prospect Lake (Steiner)
4. Bays/Peninsula (Bowker)
5. Juan de Fuca/Sooke (Golden)
6. Gorge/Lakehill (Reddy)
7. n/a
8. n/a

*please see VIPL website for contacts

1 UI Riptide (Duncan) (home)	1 UI Riptide (Duncan) 5 (home)	
8 - BYE		
4 Bays/Peninsula (Bowker) 0 (home)	W JdeF/Sooke (Golden) 1	W UI Riptide (Duncan) 3 (home)
5 Juan de Fuca/Sooke (Golden) 4		
2 UI Storm (Noon) (home)	2 UI Storm (Noon) 4 (home)	
7 - BYE		W UI Storm (Noon) 0
3 Saanich/Prospect (Steiner) 3 (home)	W Saanich/Prospect (Steiner) 1	
6 . Gorge/Lakehill (Reddy) 1		

Quarter-finals: Saturday, February 18

Semi-finals: Saturday, February 25

Finals: Saturday, March 4

Make-up weekend (weather cancellations only): March 11, April 1

Girls U15VIPL - 2016/17

Girls U15 TEAMS SEEDED FROM LEAGUE PLAY

CONTACTS

- | | |
|---|--|
| <ol style="list-style-type: none"> 1. UI Storm (Taylor) 2. Saanich Fusion/Prospect Lake (Orton) 3. UI Riptide (Barnie) 4. Gorge/Lakehill (Ryan) 5. n/a 6. n/a 7. n/a 8. n/a | <p>*please see VIPL website for contacts</p> |
|---|--|

1 UI Storm (Taylor)

(home)
8 - BYE

1 UI Storm (Taylor)	4
(home)	

W UI Storm (Taylor)	2
(home)	

4 Gorge/Lakehill (Ryan)

(home)
5 - BYE

4 Gorge/Lakehill (Ryan)	0
-------------------------	---

2 Saanich/Prospect (Orton)

(home)
7 - BYE

2 Saanich/Prospect (Orton)	0
(home)	

W UI Riptide (Barnie)	0
-----------------------	---

3 UI Riptide (Barnie)

(home)
6 . BYE

3 UI Riptide (Barnie)	2
-----------------------	---

Quarter-finals: Saturday, February 18

Semi-finals: Saturday, February 25

Finals: Saturday, March 4

Make-up weekend (weather cancellations only): March 11, April 1

Girls U16VIPL - 2016/17

Girls U16 TEAMS SEEDED FROM LEAGUE PLAY

CONTACTS

1. UI Riptide (Harris)
2. Gorge/Lakehill (Paula)
3. UI Storm (Saywell)
4. Bays/Peninsula (Cottrell)
5. Saanich Fusion/Prospect Lake (Wallace)
6. n/a
7. n/a
8. n/a

*please see VIPL website for contacts

1 UI Riptide (Harris)

(home)

8 - BYE

1 UI Riptide (Harris)

5

(home)

W UI Riptide (Harris)

5

(home)

4 Bays/Peninsula (Cottrell)

2

(home)

W Saanich/Prospect (Wallace)

1

OT

5 Saanich/Prospect (Wallace)

3

OT

2 Gorge/Lakehill (Paula)

(home)

7 - BYE

2 Gorge/Lakehill (Paula)

0

(home)

W UI Storm (Saywell)

2

3 UI Storm (Saywell)

(home)

6 -BYE

3 UI Storm (Saywell)

1

Quarter-finals: Saturday, February 18

Semi-finals: Saturday, February 25

Finals: Saturday, March 4

Make-up weekend (weather cancellations only): March 11, April 1

Girls U18VIPL - 2016/17

Girls U18 TEAMS SEEDED FROM LEAGUE PLAY

CONTACTS

- 1. UI Storm (Lee) *please see VIPL website for contacts
- 2. UI Riptide (Mohtadi)
- 3. Saanich/Prospect (Jess)
- 4. Gorge/Lakehill (Paula)
- 5. Bays/Peninsula (Parish)
- 6. n/a
- 7. n/a
- 8. n/a

1 UI Storm (Lee) (home)	1 UI Storm (Lee) (home)	5	
8 - BYE			W UI Storm (Lee) 2 (home)
4 Gorge/Lakehill (Paula) (home)	W Gorge/Lakehill (Paula)	0	
5 Bays/Peninsula (Parish) (home)		1	
2 UI Riptide (Mohtadi) (home)	2 UI Riptide (Mohtadi) (home)	3	
7 - BYE	Postponed to March 5		W UI Riptide (Mohtadi) 1
3 Saanich/Prospect (Jess) (home)	3 Saanich/Prospect (Jess)	0	
6 BYE			

Quarter-finals: Sunday, February 19

Semi-finals: Sunday, February 26

Finals: date TBD

Make-up weekend (weather cancellations only): March 12, April 2

Boys U14VIPL - 2016/17

Boys U14 TEAMS SEEDED FROM LEAGUE PLAY

CONTACTS

1. UI Riptide (McLeod) *please see VIPL website for contacts
2. Saanich Fusion/Prospect Lake (Finnigan)
3. Gorge/Lakehill (Duran)
4. Bays/Peninsula (Schrieber)
5. UI Storm (Brockhurst)
6. n/a
7. n/a
8. n/a

1 UI Riptide (McLeod)

(home)

8 - BYE

1 UI Riptide (McLeod) 2

(home)

Postponed to February 28

W UI Riptide (McLeod) 0

(home)

4 Bays/Peninsula (Schrieber) 2

(home)

W UI Storm (Brockhurst) 0

5 UI Storm (Brockhurst) 4

2 Saanich/Prospect (Finnigan)

(home)

7 - BYE

2 Saanich/Prospect (Finnigan) 4

(home)

W Saanich/Prospect (Finnigan) 2

3 Gorge/Lakehill (Duran)

(home)

3 Gorge/Lakehill (Duran) 0

6 -BYE

Quarter-finals: Sunday, February 19

Semi-finals: Sunday, February 26

Finals: Sunday, March 5

Make-up weekend (weather cancellations only): March 12, April 2

Boys U15VIPL - 2016/17

Boys U15 TEAMS SEEDED FROM LEAGUE PLAY

CONTACTS

- 1. UI Riptide (Arbour) *please see VIPL website for contacts
- 2. UI Storm (Collery)
- 3. Bays/Peninsula (Jusufi)
- 4. Saanich/Prospect (Burger)
- 5. Gorge/Lakehill (Cafferky)
- 6. n/a
- 7. n/a
- 8. n/a

1 UI Riptide (Arbour)

(home)	1 UI Riptide (Arbour) 4	
8 - BYE	(home)	
	Postponed to March 5	W UI Riptide (Arbour) 2
4 Saanich/Prospect (Burger) 2	(home)	
(home)	W Saanich/Prospect (Burger) 0	
5 Gorge/Lakehill (Cafferky) 1		

2 UI Storm (Collery)

(home)	2 UI Storm (Collery) 3	
7 BYE	(home)	
		PKs
		W UI Storm (Collery) 1
3 Bays/Peninsula (Jusufi)	(home)	
(home)	3 Bays/Peninsula (Jusufi) 2	
6 BYE		

Quarter-finals: Sunday, February 19 Semi-finals: Sunday, February 26 Finals: Wednesday, March 8
 Make-up weekend (weather cancellations only): March 12, April 2

Boys U16VIPL - 2016/17

Boys U16 TEAMS SEEDED FROM LEAGUE PLAY

CONTACTS

1. Bays/Peninsula (Kolshi)
2. Juan de Fuca/Sooke (Ooms)
3. UI Riptide (von Schilling)
4. Saanich/Prospect (Collins)
5. UI Storm (Houtman)
6. n/a
7. n/a
8. n/a

*please see VIPL website for contacts

1 Bays/Peninsula (Kolshi) (home)	1 Bays/Peninsula (Kolshi) 1 (home)	
8 - BYE	(home)	W Bays/Peninsula (Kolshi) 2 (home)
4 Saanich/Prospect (Collins) 3 (home)	W Saanich/Prospect(Collins) 0	
5 UI Storm (Houtman) 2		
<hr/>		
2 Juan de Fuca/Sooke (Ooms) (home)	2 Juan de Fuca/Sooke (Ooms) 1 (home)	
7 - BYE	(home)	W UI Riptide (von Schilling) 1
3 UI Riptide (von Schilling) (home)	3 UI Riptide (von Schilling) 4	
6 - BYE		

Quarter-finals: Sunday, February 19

Semi-finals: Sunday, February 26

Finals: Sunday, March 5

Make-up weekend (weather cancellations only): March 12, April 2

Boys U18VIPL - 2016/17

Boys U18 TEAMS SEEDED FROM LEAGUE PLAY

CONTACTS

1. Lakehill/Gorge (Duran) *please see VIPL website for contacts
2. UI Storm (Neibel)
3. UI Riptide (Rodgers)
4. Bays/Peninsula/Juan de Fuca (Trapero)
5. n/a
6. n/a
7. n/a
8. n/a

1 Lakehill/Gorge (Duran)

(home)
8 - BYE

1 Lakehill/Gorge (Duran) 0
(home)

W Bays/Pen/JdeF (Trapero) 1
(home)

4 Bays/Pen/Juan de Fuca (Trapero)

(home)
5 BYE

4 Bays/Pen/JdeF (Trapero) 1

PKs

2 UI Storm (Neibel)

(home)
7 - BYE

2 UI Storm (Neibel) 1
(home)

W UI Riptide (Rodgers) 0

3 UI Riptide (Rodgers)

(home)
6 BYE

3 UI Riptide (Rodgers) 2

Quarter-finals: Sunday, February 19 Semi-finals: Sunday, February 26 Finals: Sunday, March 5
 Make-up weekend (weather cancellations only): March 12, April 2

Appendix 4: Girls Pacific Development Cup Results

U14 Girls

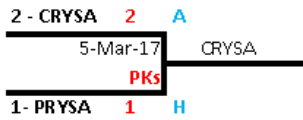

Note: CRYSA advances to Island Invitational Final April 29/30 against Cowichan

U15 Girls

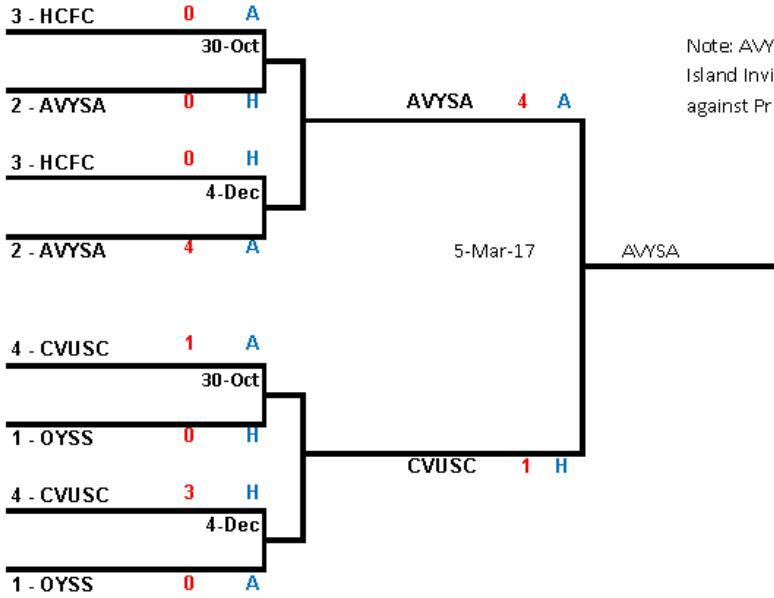

Note: AVYSA advances to Island Invitational Final April 29/30 against Prospect Lake/Peninsula

Preliminary round
U15G Points totals

Team	30-Oct	4-Dec	Total
OYSS	0	0	0
AVYSA	1	3	4
HCFC	1	0	1
CVUSC	3	3	6

U16 Girls

OYSS advances to Island Invitational Final April 29/30 against Cowichan

U17 Girls

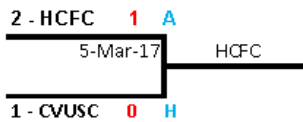

Note: HCFC advances to Island Invitational Final April 29/30 against Cowichan

U18 Girls

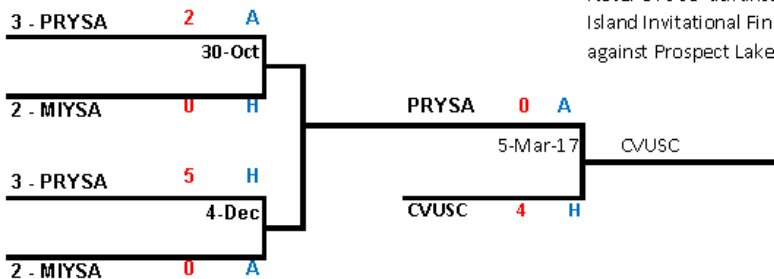

Note: CVUSC advances to Island Invitational Final April 29/30 against Prospect Lake/Peninsula

Preliminary round
U18G Points totals

Team	30-Oct	4-Dec	Total
MIYSA	0	0	0
PRYSA	3	3	6

Appendix 5: Boys Pacific Development Cup Results

U14 Boys

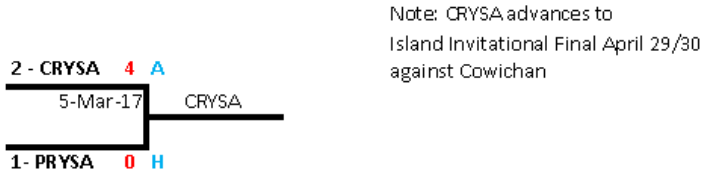

U15 Boys

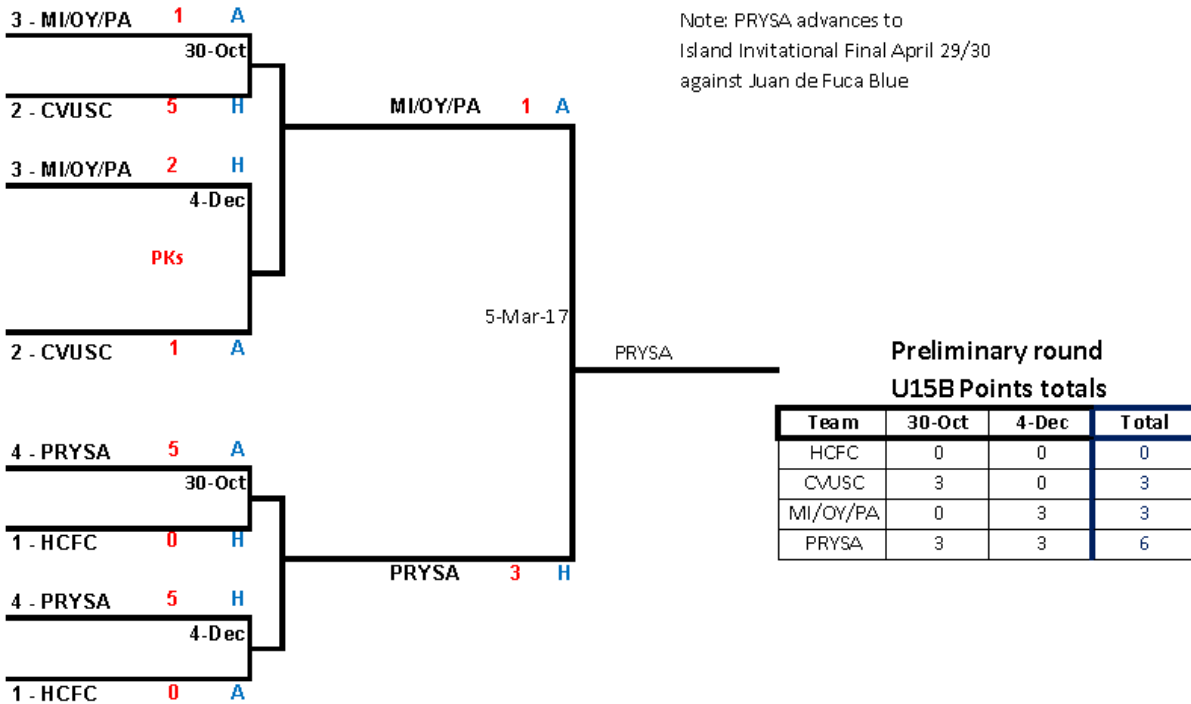

U16 Boys

No U16 team entered for 2016-17

U17 Boys

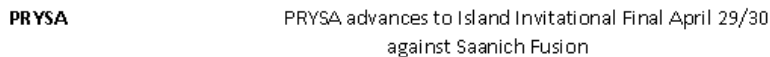

U18 Boys

