



UPPER ISLAND SOCCER ASSOCIATION

UISA – EXECUTIVE MEETING

Monday, January 16, 2017

Via Webex – 7:00 PM

Present: Kevin Cowie, Brad Nixon, Marc Paris, Carl Neibel, Sean Arbour, Sam White

Regrets: Warren Cudney

Guests: Christine Carson (UISA Administrator)

1) **Additions/Adoption of Agenda -**

MOTION: To accept the agenda as amended.

Sam/Marc

CARRIED

2) **Minutes of Previous Meeting December 5, 2016**

December 5, 2016 meeting did not have a quorum due to the snow storm that prevented board members from travelling. Any items of importance requiring board decisions were either discussed by email or moved to January exec meeting agenda.

3) **Correspondence:**

From BCSA – BC Soccer policy for Metro Select League Programming – received Jan 9, discussed with board by Kevin

Remainder of correspondence to be reported in February minutes

4) **Old Business:**

a) **Meeting dates and locations-** see list below.

b) **Pacific Development Jamboree: Sean –** no sponsorship money this year. BCSA willing to fund either MWC or PDJ – decision to keep support with MWC. Boys will play a 2 day jamboree in Campbell River on March 4 and 5. Players will be mixed rather than playing in their club-based teams. Jamboree teams will be identified at the field by pinnies. Teams will self-officiate. Signup for the event will be online, with forms already drafted by Sean, and to be circulated to teams as soon as possible by Christine.

Sam - Girls will play a one-day Jamboree March 4 in Comox Valley. Suggestions to mix players from two teams assigned to play each other at the field at game time. Plan for 3 games per team. Teams will self-officiate.

c) **U15G OYSS special permission request -OYSS U15G** have found a few new players and their roster is now up to 15. With this roster, they should not need permit players to field a team for the duration of the season. If they find themselves short again, then UISA should give them consideration.

d) **UISA league December reschedule requests –** Two U15-U18 girls games in UISA league had games postponed at their request into the winter break, then the teams were unable to complete them due to weather

MOTION: Scheduled makeup games are to take precedence over any exhibition game or non-league game commitments in UISA league. UISA rules for 2017-18 will be updated to include this amendment.

Sean/Brad

CARRIED

- e) **International students in Upper Island** - complaint received at BCSA. UISA has followed up with the club in question, and now have an answer from the club. Both emails will be forwarded to BC Soccer by Christine. BCSA is discussing how better detect and enforce international students playing sanctioned soccer.

5) **New Business:**

- a) **Edited UISA registration manual** – circulated to UISA board in December.

MOTION: to accept the UISA registration manual as edited to be put into effect for the 2017-18 Fall registration.

Kevin/Marc

CARRIED

- b) **Change of fall registration payment schedule** - Would like to change payment schedule for Fall registration from clubs, in order to make it feasible to meet BC soccer final deadline for fall registration payment, which is the same day that registration data is due in October. It is not possible to process the registration data and collect the payment fast enough to meet the deadline, and BC soccer is getting strict about meeting this date. Other districts do this by collecting 80% of their registration fees up front, while we collect only 50% in time for the initial registration due date on September 15.

MOTION: to increase first portion of the fall registration payment from the clubs to 80% from 50% in order to be able to pay both registration bills to BC soccer by the due dates

Kevin/Sam

CARRIED

- c) **Report from Riptide and Storm steering committees Carl** – the weather sucks, and lots of game and practice postponements. Gym space hard to find. Hoping the weather improves soon. Planning meeting for next year needs to be held soon. Would like a letter sent re: whitecaps communication to teams when they are interested in taking players to tournaments. **Sean** – also struggling with weather and affected by Whitecaps communication error. On the weekend, U14G unfortunately arrived in Port Alberni to be told the field was unplayable, so the trip was wasted for both them and Gorge/Lakehill. U15B Riptide and Storm will be playing a mid-week makeup on Jan 25 to get their games completed. Gala coming up at the end of February. On Feb 4, Thompson Rivers University coaches will be working with Riptide and Storm U18G and watching the U16G play. Great recruitment opportunity. CRYSA fundraiser for new fieldhouse on Feb 4 – Marine Harvest will cover 25% of cost of tickets for Riptide members who attend.
- d) **Island Invitational for Super8 teams** – several suggestions for changing rules for participation have come up – to be followed up at Tier 3 meeting. Discuss district need to provide team formation structure that is accessible to all our clubs, whether to try to run this age group as Super8 next year and how team formation may be improved. Christine to send out summary focused around points brought forward by HCFC to Tier 3 reps for consideration at the Jan 21 meeting.
- e) **BCSA** – ball size for Super8s – size 4 ball size now approved by BCSA.
- f) **BCSA – scholarship and awards:** Scholarship application form has changed for 2017 – only new format scholarship applications will be accepted – due to the district by March 21. Award nominations from clubs are welcome, and due to UISA by March 6. All forms and information available on the BCSA website Member Services menu. Christine to circulate invite to submit to clubs, UISA board members to consider potential nominees as well.

- g) **Planning for Tier3/GM meetings** – Tier 3 meeting to include Island Invite, set date for spring Tier 3, possibility of permits for PDC, GM to include U21 rule feedback from clubs, club charter checklist developed by district, UISA reg manual changes, new CSA concussion guide, CRC follow up – consequences for clubs and coaches, non-profit society act changes
- h) **Club field closure procedures** – recently challenges making calls for game days, good to have clubs clarify their procedures – HCFC and PRYSA have recently done this with UISA administrator.

Treasurer’s Report: Fall registration - income report presented

Registrar’s Report: Late registration due at the end of January.

Administrator’s Report:

League play:

- i. **BCSPL Update:** planning meeting in December, league starts up in February
- ii. **VIPL Update:** League badly affected by weather, and at least one team in most divisions now out of makeup days.
- iii. **UISA League Update:** March 5 is our last weekend of league play. January 29 indoor Jamboree for Super8 girls to include several Lower Island teams. UISA will support funding indoor jamborees next year with the same budget – good initiative.

Provincial Cup, Coastal and Island Invitational Cup play: Pacific Development Cup preliminary round games now complete – See Appendix 1 and 2 for results and final round match information now posted on the home page of the UISA website, and circulated to teams. B-cup playdown brackets also posted. A- and B-cup rosters received from all teams. U13 declarations for Island Invitational due this week, and draws to be done at the UISA general meeting on January 21.

Technical Committee:

Discipline/Officials: Several red cards issued in district for Tier 3 – one club held a discipline meeting without the direction of UISA and inappropriately including the referee involved in the incident. UISA has followed up with proper procedure. UISA to edit district game report form for next year. Issue with inappropriate calls and cards not reported have come up frequently this year. Discuss refresher education and development committee efforts to improve standards.

AOB:

MOTION: to adjourn meeting.

Sean/Brad

CARRIED

Future Meeting Dates:

UISA Executive Meeting:

Monday January 16, 2017 – via remote link – 7:00 PM

Monday February 6, 2017 – via remote link – 7:00 PM

Monday March 6, 2017 – in person or remote link – 7:00 PM

Monday April 3, 2017 – via remote link – 7:00 PM

Monday May 8, 2017 – in person or via remote link – 7:00 PM

UISA General Meeting dates:

Saturday January 21, 2017 at CVUSC clubhouse, Courtenay – 12:30 PM

Saturday, May 27, 2017 at Quality Inn Bayside, Parksville – 12:30 PM

UISA Tier 3 Steering Committee meeting dates:

Saturday, January 21, 2017 at CVUSC clubhouse, Courtenay – 11:00 AM

UISA Annual General Meeting date:

Saturday May 27, 2017 at Quality Inn Bayside, Parksville – 11:00 AM

Appendix 1: Boys Pacific Development Cup Results December 4

U14 Boys

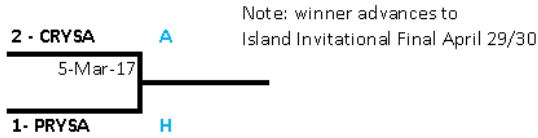

U15 Boys

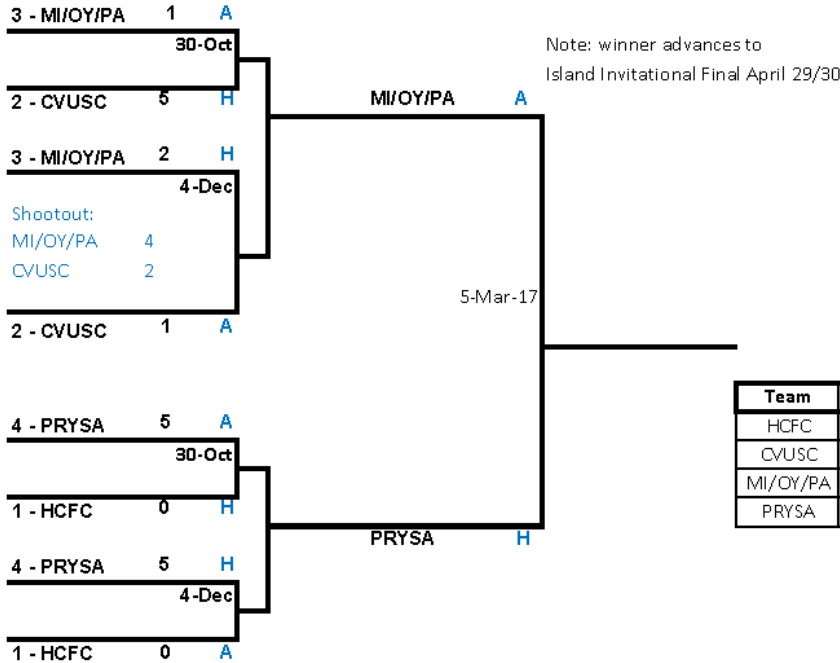

Preliminary round
U15B Points totals

Team	30-Oct	4-Dec	Total
HCFC	0	0	0
CVUSC	3	0	3
MI/OY/PA	0	3	3
PRYSA	3	3	6

U16 Boys

No UIA team entered for 2016-17

U17 Boys

No UIA team entered for 2016-17

U18 Boys

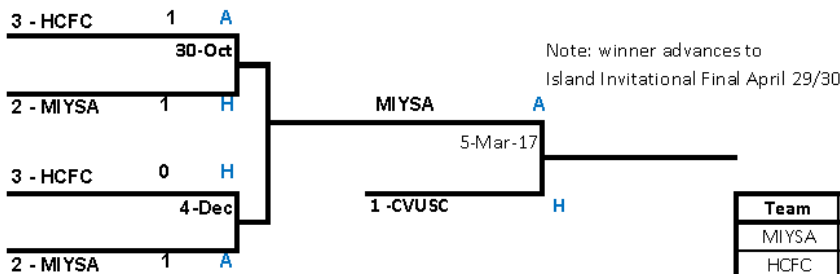

Preliminary round
U18B Points totals

Team	30-Oct	4-Dec	Total
MIYSA	1	3	4
HCFC	1	0	1

Appendix 2: Girls Pacific Development Cup Results December 4

U14 Girls

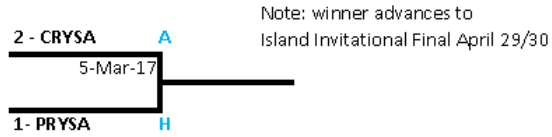

U15 Girls

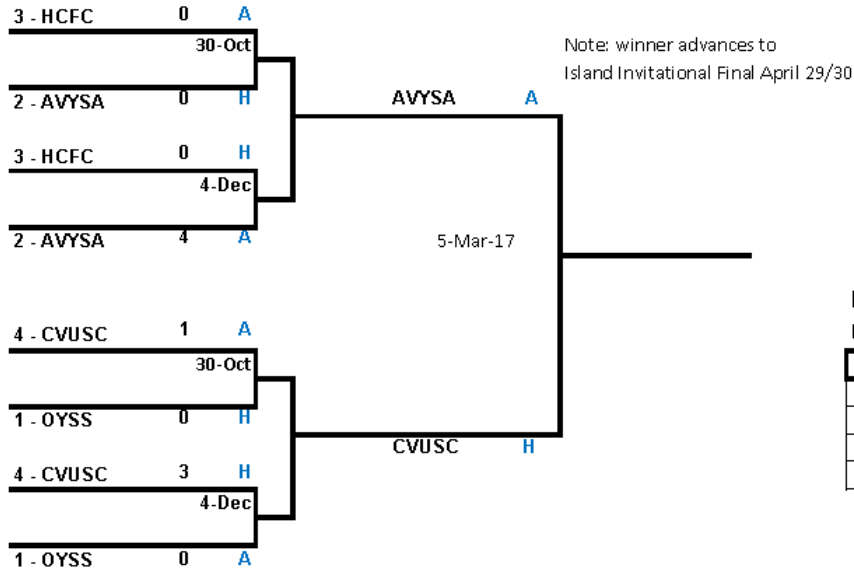

Preliminary round
U15G Points totals

Team	30-Oct	4-Dec	Total
OYSS	0	0	0
AVYSA	1	3	4
HCFC	1	0	1
CVUISC	3	3	6

U16 Girls

OYSS Will advance to Island Invitational Final April 29/30

U17 Girls

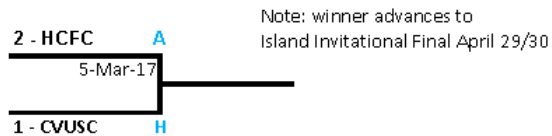

U18 Girls

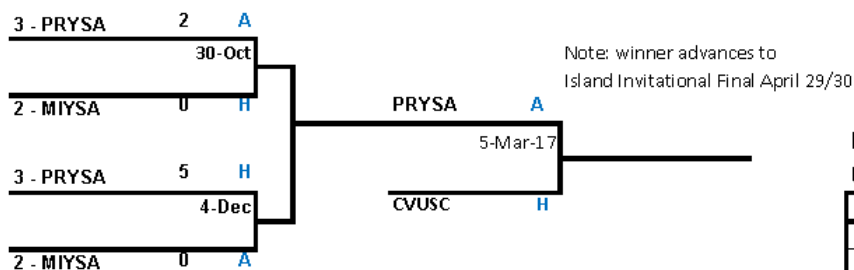

Preliminary round
U18G Points totals

Team	30-Oct	4-Dec	Total
MIYSA	0	0	0
PRYSA	3	3	6